

# INSTRUCTION MANUAL

Original instructions in Italian

SBH A10 / SBH A20 / SBH A40



Designation: AUTOMATIC LATHE GRINDER

Model: SBH A10 / SBH A20 / SBH A40



Tecno Più Srl  
Via Tempio Malatestiano, 21  
47921 Rimini (RN)  
Tel. +39 0721 476381  
website: [www.tecnopiu.it](http://www.tecnopiu.it)

<b>0.1</b>	<b>HOW TO CONSULT THE INSTRUCTION MANUAL</b>	<b>3</b>
<b>0.2</b>	<b>HOW TO USE THE INSTRUCTION MANUAL</b>	<b>4</b>
0.2.1	PURPOSE OF THE INSTRUCTION MANUAL	4
0.2.2	HOW TO STORE THE INSTRUCTION MANUAL	5
0.2.3	INSTRUCTION MANUAL UPDATE	5
<b>0.3</b>	<b>GLOSSARY</b>	<b>6</b>
<b>0.4</b>	<b>SAFETY DECALS</b>	<b>8</b>
0.4.1	HAZARD PICTOGRAMS	8
0.4.2	PROHIBITION PICTOGRAMS	8
0.4.3	MANDATORY PICTOGRAMS	9
<b>0.5</b>	<b>GENERAL SAFETY WARNINGS</b>	<b>10</b>
<b>0.6</b>	<b>LIMITATIONS AND LIABILITY</b>	<b>11</b>
<b>0.7</b>	<b>RECIPIENTS AND STORAGE</b>	<b>11</b>
<b>0.8</b>	<b>WARRANTY AND CORRECT USE</b>	<b>11</b>
<b>1.1</b>	<b>MANUFACTURER'S IDENTIFICATION DATA</b>	<b>12</b>
<b>1.2</b>	<b>DESCRIPTION OF THE SAFETY PART</b>	<b>12</b>
<b>2.1</b>	<b>REASONABLY FORESEEABLE IMPROPER USE</b>	<b>14</b>
<b>2.2</b>	<b>COPY OF THE DECLARATION OF CONFORMITY</b>	<b>15</b>
<b>3.1</b>	<b>SUPPLY STATUS AND PREPARATION</b>	<b>16</b>
<b>4.1</b>	<b>INSTALLATION</b>	<b>17</b>
<b>5.1</b>	<b>USE</b>	<b>18</b>
<b>5.2</b>	<b>REPLACING ABRASIVE BELT</b>	<b>19</b>
<b>5.3 m</b>	<b>REPLACEMENT OF ROTARY DAMPER</b>	<b>19</b>
<b>6.1</b>	<b>MAINTENANCE FOR INSTALLATION TECHNICIAN</b>	<b>20</b>
<b>7.1</b>	<b>GENERAL WARNINGS</b>	<b>21</b>
<b>7.2</b>	<b>DECOMMISSIONING</b>	<b>21</b>
<b>7.3</b>	<b>WASTE DISPOSAL AND PACKAGING</b>	<b>22</b>
<b>7.4</b>	<b>SPARE PARTS AND SERVICE</b>	<b>22</b>
<b>7.5</b>	<b>SPARE PARTS</b>	<b>23</b>

## 0.1 HOW TO CONSULT THE INSTRUCTION MANUAL

This instruction manual consists of:

- COVER WITH SAFETY PART IDENTIFICATION
- TABLE OF CONTENTS
- INSTRUCTIONS AND/OR NOTES ON THE SAFETY PART
- ANNEXES

Consult the COVER to find the safety part model covered in the manual and in your possession.

By consulting the TABLE OF CONTENTS, it is possible to find the CHAPTER and PARAGRAPH under which all the notes relating to a particular topic are listed.

All INSTRUCTIONS AND/OR NOTES are intended to identify the safety warnings, correct procedures and operational qualifications required for proper operation of the safety component.

Any ANNEXES at the end of this publication are an integral part of this manual.

The "ORIGINAL INSTRUCTIONS" contained in this instruction manual are written in the language of the manufacturer (Italian). All other versions translated into other languages are to be considered 'TRANSLATION OF THE ORIGINAL INSTRUCTIONS'.

In the event of any inconsistency between the original ITALIAN version and its translated copy, the original shall prevail.



**Information preceded by the symbol must be scrupulously observed.**



**The information in this warning indicates a PROHIBITION and must be scrupulously observed.**



**The information in this warning indicates an OBLIGATION and must be scrupulously observed.**



**The information in this warning indicates a DANGER or RESIDUAL RISK and must be scrupulously observed.**

## 0.2 HOW TO USE THE INSTRUCTION MANUAL

### 0.2.1 PURPOSE OF THE INSTRUCTION MANUAL

This INSTRUCTION MANUAL constitutes the guide to the INSTALLATION, USE, MAINTENANCE and DE-COMMISSIONING of the safety component in question.

It is an integral part of the safety part and provides all the necessary information for:

- Knowing the limitations
- Informing all the operators about the safety issues;
- Handling, placing and installation;
- The intended use for which it was designed and built;
- Reasonably foreseeable misuse;
- Procedures for use;
- Setting and adjustment procedures;
- Maintenance procedures
- Disposal and dismantling procedures.



**The instruction manual must be read by the operators who use the safety component in the production cycle of the company where it is installed and by the operators who periodically carry out maintenance operations within the company.**

## 0.2.2 HOW TO STORE THE INSTRUCTION MANUAL

Use the manual so as not to damage the content.  
Do not remove, tear or rewrite parts of the manual for any reason.  
Keep the manual in a place protected from moisture and heat.



**Provide the instruction manual to any other User or subsequent Owner of the safety component.**



**The INSTRUCTIONS MANUAL is an integral part of the safety component: keep this Manual throughout the entire service life of the safety component and ensure that any updates sent by the manufacturer are incorporated into this publication.**

## 0.2.3 INSTRUCTION MANUAL UPDATE

In the event of changes to the safety component installed at the customer's premises, agreed with the Manufacturer and involving the modification of one or more chapters of the Instruction Manual, it will be the Manufacturer's responsibility, by referring to the distribution list in its archives, to send the chapters affected by the change with the new revision level, the new home page and the new table of contents, which shows the new global revision level of the Instruction Manual according to the revision level of the component chapters.

It is the responsibility of the user, following the instructions accompanying the updated documentation, to replace all copies held of the old chapters with the new ones, the cover page and the index with those of the new revision level.

## 0.3 GLOSSARY

- **Danger**  
Potential source of damage.
- **Hazard zone**  
Any zone inside and/or near a machine in which the presence of an exposed person poses a risk to that person's health and safety.
- **Exposed person**  
Any person who is wholly or partially in a hazardous zone.
- **Operator**  
The person(s) in charge of installing, operating, adjusting, cleaning, repairing and moving a machine and its safety component or performing maintenance thereof;
- **Risk**  
A combination of the likelihood and the severity of an injury or damage to health that may arise in a hazardous situation;
- **Planned use**  
Use the machine and the safety component in accordance with the information provided in the operating instructions.
- **Reasonably foreseeable misuse**  
The use of the machine and the safety component in a way other than indicated in the instructions for use, but which may result from easily foreseeable human behaviour.
- **Man - machine interaction**  
Any situation in which an operator must interact with the machine. This can occur at any operating stage and at any time during the life of the machine. The same applies to the safety part.
- **Operator qualification**  
The minimum skill level that the operator must possess to carry out the operation described.
- **Number of operators**  
The number of operators required to carry out the described operation in the best way. This number derives from careful analysis by the "Manufacturer" and, therefore, using a different number of people may prevent you from achieving the desired result or may risk the safety of the staff involved.
- **Machine Status**
  - The operating mode runs automatically, with maintained action command (JOG), stop, etc.;
  - The condition of the safety devices on the machine: guards included, guards excluded, emergency stop pressed, type of isolation of energy sources, etc.
- **Guard**  
A part of the machine used in such a way as to offer protection by creating a physical barrier.

- **Interlocked guard**  
Guard associated to an interlocking device that guarantees that:
  - The hazardous operations of the machine "affected" by the guard can not be carried out until the guard has been closed;
  - If the guard is opened during hazardous machine operations, a stop command is given;
  - Closing the guard permits hazardous machine operations "affected" by the guard to be carried out, but not the startup commands.
- **Safety device**  
A device (other than a guard) which eliminates or reduces the risk, of its own or associated to a guard.
- **Safe stop**  
Machine stopped with safety measures that prevent dangerous parts from unexpectedly starting.
- **Residual risk**  
Risk that could not be eliminated or sufficiently reduced in the design phase and for which the guards not (or not entirely) effective against. The manual includes information about the presence of risk and gives instructions and warnings to allow you to overcome it.
- **Safety part**  
A fault or poor operation in such a component jeopardises the safety and/ or health of exposed persons (e.g.: lifting equipment, a fixed, mobile, adjustable etc guard, an electrical, electronic, pneumatic optical or hydraulic device that interlocks a guard etc).
- **Safety-related part of a control system; SRP/CS**  
Part of a control system that responds to safety-related input signals and generates safety-related output signals.
- **Safety function**  
Function of a machine whose failure can lead to an immediate increase in risk(s).

## 0.4 SAFETY DECALS

The "SAFETY" symbols described below are used for warning the operator on the dangers that may affect its safety.







The pictograms contained in:

- A triangle indicates DANGERS.
- A BLUE circle imposes an OBLIGATION.
- A RED circle imposes a PROHIBITION.
- A square/rectangle provides INFORMATION.











**The following pages contain a glossary of the different pictograms. Only those related to the relevant procedure will be included in the manual. It is the responsibility of the user to identify and apply any other pictograms on the machine in accordance with ANNEX XXV of L.D. April 9, 2008, No. 81, and depending on the working environment where the safety component is installed and used.**

### 0.4.1 HAZARD PICTOGRAMS











SYM-BOLS	DESCRIPTION	SYM-BOLS	DESCRIPTION
	General hazard.		Danger of shearing upper limbs.
	Electrical hazard.		Danger of moving parts.
	Danger of crushing upper and lower limbs.		Danger of entanglement and dragging.
	Danger of crushing upper limbs.		

### 0.4.2 PROHIBITION PICTOGRAMS

SYM-BOLS	DESCRIPTION	SYM-BOLS	DESCRIPTION
	General restriction.		Prohibition to push.
	Forbidden to remove the safety devices.		Do not extinguish fire with water.
	Prohibition of intervention on moving parts.		Prohibition to change the status of the switch.
	Keep hands clear.		Prohibition of placing heavy loads.
	No smoking or open flames.		



## 0.4.3 MANDATORY PICTOGRAMS

SYM-BOLS	DESCRIPTION	SYM-BOLS	DESCRIPTION
	Generic obligation.		Obligation to wear the protective shield.
	Obligation to read the instruction manual.		Obligation to wear hearing protection.
	Protective gloves must be worn.		Obligation to check the safety devices.
	Safety shoes must be worn.		Obligation to ensure grounding.
	Obligation to wear protective helmet.		Safety goggles must be worn.
	Protective clothing must be worn.		

## 0.5 GENERAL SAFETY WARNINGS



**Please read this manual carefully before commissioning, operating, maintaining or otherwise working on the safety component.**

- Personnel involved in the use and maintenance of the safety component must wear clothing that is appropriate for the working environment and the situation in which they find themselves; in particular, the use of very loose clothing, chains, bracelets, rings or anything else that has a tendency to become entangled with moving parts must be avoided.
- Before starting work, personnel must be fully aware of the position and operation of all controls and the characteristics of the machine on which the safety component is mounted.
- It is absolutely forbidden to carry out any maintenance, adjustment or setting operations with moving parts; before carrying out any of these operations, follow the specific instructions in each paragraph.
- Use only original parts made by the Manufacturer.
- During all maintenance, repair or adjustment operations, it is always useful to affix a warning sign on the control panel on board the machine or on the general power supply switches (electric, pneumatic, etc.); this sign may state the following: ATTENTION! DO NOT TOUCH - MAINTENANCE IN PROGRESS. Any maintenance work must only be carried out with the machine switched off and disconnected, by qualified personnel and when the prerequisites for safe working on the safety component are in place. In order to isolate the machine from energy sources, disconnect voltage through the main switches and lock them.

Some of the types of switches used and the padlocking operation are shown in the figure.



- Operators are obliged to immediately report to their direct supervisors any deficiency and/or potential dangerous situation that may occur on the safety component; this must be done after it has been shut down and sectioned.
- Do not, for any reason, modify parts of the safety component (such as attachments, drillings, finishes) to fit additional devices; in the event of a malfunction due to a failure to comply with the above, the manufacturer is not liable for the consequences.
- For operation and maintenance of commercial components mounted on the safety component, please refer to the manuals enclosed or retrievable online.

## 0.6 LIMITATIONS AND LIABILITY

Any operation NOT explicitly described or NOT explicitly permitted by this manual is strictly forbidden. No liability, civil, criminal or otherwise, can be attributed to its manufacturer in the event of an accident occurring due to failure to comply with safety regulations.

Whoever purchases and/or gives or receives such equipment without acknowledging the validity of the preceding clauses shall immediately renounce the use of such equipment, otherwise the preceding clauses shall be deemed to be explicitly and irrevocably accepted by the mere switching on and use of the equipment.

## 0.7 RECIPIENTS AND STORAGE

The RECIPIENTS of this manual are:

- Technician Installer: the technical personnel in charge of installing and commissioning the safety component on the machine, who, in addition to being professionally trained in their task, must read the manuals paying particular attention to safety regulations;
- User: personnel assigned to work on the machine, who, in addition to being professionally trained in their task, must read the manuals paying particular attention to the safety regulations and the paragraphs relating to their competence.
- Maintenance Technician: technical personnel in charge of ordinary and extraordinary maintenance of the equipment, must read the manuals paying particular attention to the safety regulations and the paragraphs relating to their competence.

## 0.8 WARRANTY AND CORRECT USE

This Conventional Warranty offered by the manufacturer will be fully valid during the period indicated below, exclusively in accordance with the provisions:

- For the duration of 12 (twelve) months from receipt of the product, commencing on the date stated on the relevant transport document (DDT), unless otherwise defined in the sales contract with the purchasing party.
- The warranty covers only replaced parts, with the exception of labour.
- Components subject to unavoidable wear and tear due to normal service, such as plastic protection shields and the like, are not covered by the Warranty; damage to the safety component caused by: Transport and/or handling - Operator errors - Incorrect connection to the machine's electrical system - Failure to carry out the maintenance required by this manual - Faults and/or breakage of the machine on which it is installed that cannot be attributed to its malfunction.

## 1.1 MANUFACTURER'S IDENTIFICATION DATA

**COMPANY NAME:**

**TECNO PIÙ S.r.l.**

**Registered office:**

Via Tempio Malatestiano, 21  
47921 Rimini (RN) – Italy

**Offices and factory:**

Via Pio la Torre, 5  
61010 Tavullia (PU) – Italy

**Ph.**

+39 0721 476381

**E-mail**

info@tecnopiu.it

**Website:**

www.tecnopiu.it

## 1.2 DESCRIPTION OF THE SAFETY PART

The safety component: mod. SBH A10 / SBH A20 / SBH A40 is a tool for sanding and finishing bars for conventional lathes, with automatic movement of the abrasive belt, designed in accordance with UNI EN ISO 23125 6.2.1 P (prohibition of using the hand to perform machining operations), which safely replaces the same dangerous operation usually performed manually.

The device is fixed in the lathe's tool turret and, with its special design, with three different opening positions of the front support arms, allows the grinding of bars of different diameters. Thanks to the tension springs, the belt always adheres optimally to the surface. The perfect efficiency of the abrasive part of the grinding belt is ensured by an automatic sliding system (patented) that exploits the rotary movement of the workpiece.



**Before proceeding with the installation of the safety device, check and where necessary prepare the machine with appropriate support brackets, holes and anything else for the correct anchoring of the safety device to the machine itself. Carefully follow the measurements and centre distances of the fixing brackets supplied with the safety device.**



CODE SBH A10	Pos	Max. Ø	A	B	Belt	Kg
SBH A10	1	Ø 120	130	295	25 x 762	4.7
SBH A10	2	Ø 160	170	280	25 x 762	
SBH A10	3	Ø 210	220	260	25 x 762	

CODE SBH A20	Pos	Max. Ø	A	B	Belt	Kg
SBH A20	1	Ø 200	210	340	50 x 915	5.0
SBH A20	2	Ø 220	230	320	50 x 915	
SBH A20	3	Ø 260	270	275	50 x 915	

CODE SBH A40	Pos	Max. Ø	A	B	Belt	Kg
SBH A40	1	Ø 310	330	475	100 x 1372	9.
SBH A40	2	Ø 350	360	440	100 x 1372	
SBH A40	3	Ø 380	395	415	100 x 1372	



**The safety component has been designed and built to work in a professional environment and by professional operators who are informed and trained for this purpose.**



**The safety component has been designed and built for only those machine types whose characteristics are listed in this manual**



**Worn parts of the safety component must be properly checked and, if necessary, replaced with original spare parts.**



**For proper use of the safety component, good maintenance and cleaning of the component must be scrupulously observed.**

### 2.1 REASONABLY FORESEEABLE IMPROPER USE

Reasonably foreseeable misuse includes all uses not explicitly mentioned in this manual, in particular:

- Use of the safety component in a non-professional environment or by non-professional personnel;
- Use of the safety component by unauthorised and untrained personnel;
- Use of the safety part in an environment other than that specified in the contract;
- Use of the safety component in conditions of use outside the limits given in this manual;
- Use of products other than those specified in the contract and possibly in this manual.
- Use of the safety component damaged or with missing parts.



**The above reasonably foreseeable misuse and all uses not explicitly stated in this manual are prohibited.**



**It is forbidden to use the safety component in environments with explosive atmospheres.**



**It is forbidden to make changes to the safety component.**



**Modifications to the safety component for uses other than those intended shall invalidate the conformity of the safety component and the manufacturer's liability.**



**It is forbidden to use the safety component until it has been correctly installed. It is strictly forbidden to tamper with, bypass or disable the safety devices on the component.**



**It is forbidden to remove and tamper with safety devices;  
Tampering with them exposes the operator to contact with dangerous machine parts.**



**It is forbidden to use the safety component without the appropriate personal protective equipment.**



**It is absolutely forbidden to remove the protective cover while the device is working**



**The operator must use the personal protective equipment intended for use with the machine.**

## 2.2 COPY OF THE DECLARATION OF CONFORMITY

Below is a copy of the Declaration of Conformity.

The original copy accompanies the safety component and is filed with the manufacturer.



SEDE LEGALE:  
Via Tempio Malatestiano, 21  
47921-RIMINI (RN)-ITALY

SEDE OPERATIVA:  
Via Pio La Torre, 5  
61010-TAVULLIA (PU)-ITALY  
Tel. +39 0721 476381-476131  
Fax. +39 0721 476608  
www.tecnopiu.it-info@tecnopiu.it

TECNOPIÙ S.R.L. - COD. FISCALE/P.NA/REG. IMP. RMINN IT03657258487 - R.E.A. N. 382624 - CAPITALE SOCIALE 58.888,88 LV.

**DICHIARAZIONE DI CONFORMITÀ**  
**DECLARATION OF CONFORMITY**  
**DÉCLARATION DE CONFORMITÉ**  
**DECLARACIÓN DE CONFORMIDAD**  
**KONFORMITÄTSEKLRUNG**  
**ДЕКЛАРАЦИЯ СООТВЕТСТВИЯ**

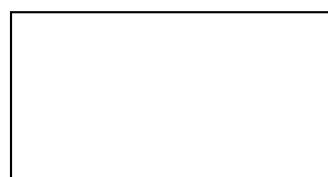

<p>è conforme alle direttive: - Direttiva 2006/42/CE</p> <p>Norme armonizzate: UNI EN ISO 12100:2010 CEI EN 60204-1:2018 UNI EN ISO 14120:2015</p> <p>Persona autorizzata alla compilazione del fascicolo tecnico: Tecno Più srl Via Tempio Malatestiano, 21 47921 Rimini (RN) - ITALY</p>	<p>conforms to directives: - Directive 2006/42/EC</p> <p>Harmonized standards: UNI EN ISO 12100:2010 CEI EN 60204-1:2018 UNI EN ISO 14120:2015</p> <p>Authorized person to fill in the technical file: Tecno Più srl Via Tempio Malatestiano, 21 47921 Rimini (RN) - ITALY</p>	<p>conforme aux directives: - Directive 2006/42/CE</p> <p>Normes harmonisées: UNI EN ISO 12100:2010 CEI EN 60204-1:2018 UNI EN ISO 14120:2015</p> <p>Personne autorisée à compléter le dossier technique: Tecno Più srl Via Tempio Malatestiano, 21 47921 Rimini (RN) - ITALY</p>
--	--	---



<p>conforme a las directivas: - Directiva 2006/42/CE</p> <p>Normas armonizadas: UNI EN ISO 12100:2010 CEI EN 60204-1:2018 UNI EN ISO 14120:2015</p> <p>Persona autorizada a la elaboración módulo técnico: Tecno Più srl Via Tempio Malatestiano, 21 47921 Rimini (RN) - ITALY</p>	<p>Entsprechend den Richtlinien: - Richtlinie 2006/42/CE</p> <p>Harmonisierte Normen: UNI EN ISO 12100:2010 CEI EN 60204-1:2018 UNI EN ISO 14120:2015</p> <p>Berechtigter zum Ausfüllen der technischen Unterlagen: Tecno Più srl Via Tempio Malatestiano, 21 47921 Rimini (RN) - ITALY</p>	<p>Соответствует директивам: - Директива 2006/42/ЕС</p> <p>Гармонизированные стандарты: UNI EN ISO 12100: 2010 CEI EN 60204-1: 2018 UNI EN ISO 14120: 2015 Уполномоченное лицо для заполнения технической документации: Tecno Più srl Via Tempio Malatestiano, 21 47921 Rimini (RN) – ИТАЛИЯ</p>
--	---	--

Rimini,

Legale rappresentante  
Legal representative  
Représentant légal  
Representante legal  
Rechtsvertreter  
Законный представитель



### 3.1 SUPPLY STATUS AND PREPARATION

The costs, as well as the preparation of the safety component on the machine, are borne by the Customer and include:

- Prepared for anchoring on the machine;
- The Power Supply of the machine, in accordance with the Standards in force in the Country of use.

Installation requires a manoeuvring area around the machine appropriate to the requirements of the operations to be performed.

The general packaging is in any case in the form of one or more sturdy cardboard boxes, in which the device, the protective casing, an abrasive belt and a spare shock absorber are appropriately placed inside, which are in turn well protected by suitable material (cardboard and expanded polystyrene plugs).



## 4.1 INSTALLATION

ATTENTION! The machine must be stationary during these operations.



Place on the tool holder



Securely fasten



Correct position

### 5.1 USE

Starting from the initial position, start the lathe and carefully bring the abrasive tool into the working position. The belt will rotate at a speed directly proportional to the pressure exerted on the workpiece. In this way, the belt will always work optimally with absolutely even belt usage.

**CAUTION:** The device must work with a rotation speed of the pulley connected to the shock absorber NOT exceeding 10 cycles/min. This speed can be verified by checking the belt's running time between the two indicators in the window in the protective casing and comparing it with the table on the sides of the casing.

**WARNING:** It is strictly forbidden by the manufacturer and current regulations to use any electrical equipment to rotate the abrasive belt in any other way.

## 5.2 REPLACING ABRASIVE BELT

ATTENTION! The machine must be stationary during these operations.



Remove the guard



Removing the belt



Lift the arm



Reposition the belt

## 5.3 REPLACEMENT OF ROTARY DAMPER



Initial position



Loosen the screws



Remove the shock absorber

### 6.1 MAINTENANCE FOR INSTALLATION TECHNICIAN

Any cleaning of the safety component must be carried out with the machine switched off and performed by personnel suitably trained in routine maintenance operations.

Cleaning of the various components can be carried out with common universal degreasers, absolutely no corrosive agents or solvents should be used.



**IT IS FORBIDDEN TO USE ALCOHOL, SOLVENTS OR AGGRESSIVE DEGREASERS.**

## 7.1 GENERAL WARNINGS

- The disposal and scrapping of the safety component must be carried out by qualified personnel who are familiar with the safety regulations for the type of work to be performed.
- As the safety component is disconnected from the various sources of energy, the operator must wear the personal protective equipment deemed most appropriate according to the type of residual or inherent danger when disassembling the parts.
- During disassembly, ensure that the parts of the safety component to be removed are of a weight that can be lifted individually by the operator and that there is no danger of falling during disconnection.
- In case of past use of the safety component with toxic materials for dismantling, it is recommended to use protection for the respiratory tract and exposed parts.
- The treatment to be reserved in this case must be the specific knowledge of the user, who must apply the strictest safety and disposal regulations.



**Please refer to section 0.5 GENERAL SAFETY WARNINGS.**

## 7.2 DECOMMISSIONING

If it is necessary to take the safety component out of service, it is also necessary to carry out all necessary operations to take the machine itself out of service, because, **THE MACHINE IS NOT IN SAFE CONDITIONS.**

## 7.3 WASTE DISPOSAL AND PACKAGING

If you decide to no longer use the safety component which is the subject of this manual, because it is obsolete or irretrievably defective or worn out, take it out of service using the following procedures:

1. Make sure the machine is stopped and disconnected from the main power supply.
2. Check for the absence of residual, potential and kinetic energies.
3. If it is useful to reduce its size and/or facilitate transport, disassemble its various parts very carefully.

Dispose of it in accordance with the regulations in force in your country of use, contacting companies specialised in scrapping, recycling and disposal of equipment.

The correct disposal of this product contributes to preventing potential negative consequences that might derive from an inadequate disposal of the product.

The equipment consists of non-biodegradable parts and substances that can pollute the environment if not properly disposed of, and parts of these materials can be recycled without polluting the environment.

It is your and our duty to contribute to human health and environmental protection.

Dispose of packaging materials by separating them according to their nature and according to the relevant legislation in the country of use.

Materials bearing this symbol are recyclable and must be stored in the appropriate spaces and/or containers.

Enquire with the competent local authority.

## 7.4 SPARE PARTS AND SERVICE

Contact your dealer or the company's Technical Customer Service directly, providing the necessary data that can be found on the nameplate on the guard:

- Type of guard;
- Serial number;
- Date of purchase;
- Moreover, supply all the information that concerns the experienced inconvenience.

## 7.5 SPARE PARTS

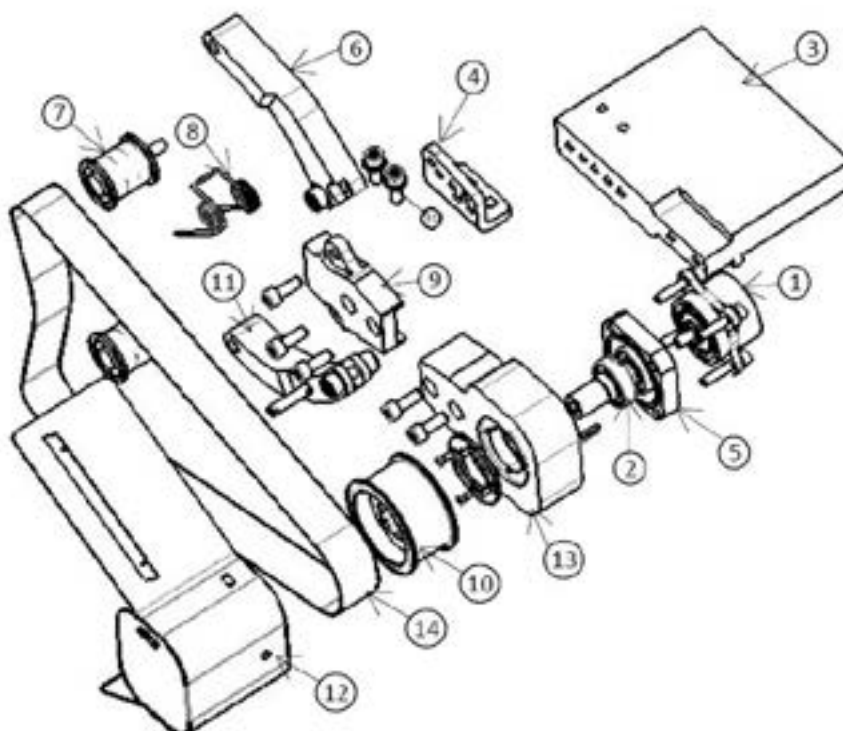

1	Rotating shock absorber
2	Bearing
3	L25CD0037
4	L25CD0047
5	L25CD0048
6	L25CD0046 - L25CD0051
7	L25GR0003
8	Torsion spring
9	L25GR0038
10	L25GR0043
11	L25CD0044 - L25CD0052
12	Protective casing
13	L25GR0039
14	Abrasive belt



Tecno Più Srl  
Via Tempio Malatestiano, 21  
47921 Rimini (RN)  
Tel. +39 0721 476381  
website: [www.tecnopiu.it](http://www.tecnopiu.it)