

INSTRUCTION MANUAL

Original instructions in Italian

PAL 01



Designation: GUARD FOR BORING MACHINE

Model: PAL 01



Tecno Più Srl
Via Tempio Malatestiano, 21
47921 Rimini (RN)
Tel. +39 0721 476381
website: www.tecnopiu.it

0.1	HOW TO CONSULT THE INSTRUCTION MANUAL	4
0.2	HOW TO USE THE INSTRUCTION MANUAL	5
0.2.1	PURPOSE OF THE INSTRUCTION MANUAL	5
0.2.2	HOW TO STORE THE INSTRUCTION MANUAL	5
0.2.3	INSTRUCTION MANUAL UPDATE	5
0.3	GLOSSARY	6
0.4	SAFETY DECALS	8
0.4.1	HAZARD PICTOGRAMS	8
0.4.2	PROHIBITION PICTOGRAMS	8
0.4.3	MANDATORY PICTOGRAMS	9
0.5	GENERAL SAFETY WARNINGS	10
0.6	LIMITATIONS AND LIABILITY	11
0.7	RECIPIENTS AND STORAGE	11
0.8	WARRANTY AND CORRECT USE	11
1.1	MANUFACTURER'S IDENTIFICATION DATA	12
1.2	DESCRIPTION OF THE SAFETY PART	12
2.1	REASONABLY FORESEEABLE IMPROPER USE	14
2.1.1	MICROSWITCHES	15
2.2	COPY OF THE DECLARATION OF CONFORMITY	16
3.1	SUPPLY STATUS AND PREPARATION	17
4.1	PREPARATION	18
4.2	ASSEMBLY	18
4.3	INSTALLATION	18
4.4	ELECTRICAL CONNECTION	19
4.5	START-UP	19
4.6	RESPONSIBILITY OF THE INSTALLER	19
5.1	WORKSTATION	20
5.2	BEFORE STARTING ANY WORK	20
6.1	MAINTENANCE FOR INSTALLATION TECHNICIAN	21
7.1	GENERAL WARNINGS	22

7.2	DECOMMISSIONING	22
7.3	WASTE DISPOSAL AND PACKAGING	23
7.4	SPARE PARTS AND SERVICE	23

0.1 HOW TO CONSULT THE INSTRUCTION MANUAL

This instruction manual consists of:

- COVER WITH SAFETY PART IDENTIFICATION
- TABLE OF CONTENTS
- INSTRUCTIONS AND/OR NOTES ON THE SAFETY PART
- ANNEXES

Consult the COVER to find the safety part model covered in the manual and in your possession.

By consulting the TABLE OF CONTENTS, it is possible to find the CHAPTER and PARAGRAPH under which all the notes relating to a particular topic are listed.

All INSTRUCTIONS AND/OR NOTES are intended to identify the safety warnings, correct procedures and operational qualifications required for proper operation of the safety component.

Any ANNEXES at the end of this publication are an integral part of this manual.

The "ORIGINAL INSTRUCTIONS" contained in this instruction manual are written in the language of the manufacturer (Italian). All other versions translated into other languages are to be considered 'TRANSLATION OF THE ORIGINAL INSTRUCTIONS'.

In the event of any inconsistency between the original ITALIAN version and its translated copy, the original shall prevail.



Information preceded by the symbol must be scrupulously observed.



The information in this warning indicates a PROHIBITION and must be scrupulously observed.



The information in this warning indicates an OBLIGATION and must be scrupulously observed.



The information in this warning indicates a DANGER or RESIDUAL RISK and must be scrupulously observed.

0.2 HOW TO USE THE INSTRUCTION MANUAL

0.2.1 PURPOSE OF THE INSTRUCTION MANUAL

This INSTRUCTION MANUAL constitutes the guide to the INSTALLATION, USE, MAINTENANCE and DE-COMMISSIONING of the safety component in question.

It is an integral part of the safety part and provides all the necessary information for:

- Knowing the limitations
- Informing all the operators about the safety issues;
- Handling, placing and installation;
- The intended use for which it was designed and built;
- Reasonably foreseeable misuse;
- Procedures for use;
- Setting and adjustment procedures;
- Maintenance procedures
- Disposal and dismantling procedures.



The instruction manual must be read by the operators who use the safety component in the production cycle of the company where it is installed and by the operators who periodically carry out maintenance operations within the company.

0.2.2 HOW TO STORE THE INSTRUCTION MANUAL

Use the manual so as not to damage the content.

Do not remove, tear or rewrite parts of the manual for any reason.

Keep the manual in a place protected from moisture and heat.



Provide the instruction manual to any other User or subsequent Owner of the safety component.



The INSTRUCTIONS MANUAL is an integral part of the safety component: keep this Manual throughout the entire service life of the safety component and ensure that any updates sent by the manufacturer are incorporated into this publication.

0.2.3 INSTRUCTION MANUAL UPDATE

In the event of changes to the safety component installed at the customer's premises, agreed with the Manufacturer and involving the modification of one or more chapters of the Instruction Manual, it will be the Manufacturer's responsibility, by referring to the distribution list in its archives, to send the chapters affected by the change with the new revision level, the new home page and the new table of contents, which shows the new global revision level of the Instruction Manual according to the revision level of the component chapters.

It is the responsibility of the user, following the instructions accompanying the updated documentation, to replace all copies held of the old chapters with the new ones, the cover page and the index with those of the new revision level.

0.3 GLOSSARY

- **Danger**
Potential source of damage.
- **Hazard zone**
Any zone inside and/or near a machine in which the presence of an exposed person poses a risk to that person's health and safety.
- **Exposed person**
Any person who is wholly or partially in a hazardous zone.
- **Operator**
The person(s) in charge of installing, operating, adjusting, cleaning, repairing and moving a machine and its safety component or performing maintenance thereof;
- **Risk**
A combination of the likelihood and the severity of an injury or damage to health that may arise in a hazardous situation;
- **Planned use**
Use the machine and the safety component in accordance with the information provided in the operating instructions.
- **Reasonably foreseeable misuse**
The use of the machine and the safety component in a way other than indicated in the instructions for use, but which may result from easily foreseeable human behaviour.
- **Man - machine interaction**
Any situation in which an operator must interact with the machine. This can occur at any operating stage and at any time during the life of the machine. The same applies to the safety part.
- **Operator qualification**
The minimum skill level that the operator must possess to carry out the operation described.
- **Number of operators**
The number of operators required to carry out the described operation in the best way. This number derives from careful analysis by the "Manufacturer" and, therefore, using a different number of people may prevent you from achieving the desired result or may risk the safety of the staff involved.
- **Machine Status**
 - The operating mode runs automatically, with maintained action command (JOG), stop, etc.;
 - The condition of the safety devices on the machine: guards included, guards excluded, emergency stop pressed, type of isolation of energy sources, etc.
- **Guard**
A part of the machine used in such a way as to offer protection by creating a physical barrier.

- **Interlocked guard**
Guard associated to an interlocking device that guarantees that:
 - The hazardous operations of the machine "affected" by the guard can not be carried out until the guard has been closed;
 - If the guard is opened during hazardous machine operations, a stop command is given;
 - Closing the guard permits hazardous machine operations "affected" by the guard to be carried out, but not the startup commands.
- **Safety device**
A device (other than a guard) which eliminates or reduces the risk, of its own or associated to a guard.
- **Safe stop**
Machine stopped with safety measures that prevent dangerous parts from unexpectedly starting.
- **Residual risk**
Risk that could not be eliminated or sufficiently reduced in the design phase and for which the guards not (or not entirely) effective against. The manual includes information about the presence of risk and gives instructions and warnings to allow you to overcome it.
- **Safety part**
A fault or poor operation in such a component jeopardises the safety and/ or health of exposed persons (e.g.: lifting equipment, a fixed, mobile, adjustable etc guard, an electrical, electronic, pneumatic optical or hydraulic device that interlocks a guard etc).
- **Safety-related part of a control system; SRP/CS**
Part of a control system that responds to safety-related input signals and generates safety-related output signals.
- **Safety function**
Function of a machine whose failure can lead to an immediate increase in risk(s).

0.4 SAFETY DECALS

The "SAFETY" symbols described below are used for warning the operator on the dangers that may affect its safety.







The pictograms contained in:

- A triangle indicates DANGERS.
- A BLUE circle imposes an OBLIGATION.
- A RED circle imposes a PROHIBITION.
- A square/rectangle provides INFORMATION.











The following pages contain a glossary of the different pictograms. Only those related to the relevant procedure will be included in the manual. It is the responsibility of the user to identify and apply any other pictograms on the machine in accordance with ANNEX XXV of L.D. April 9, 2008, No. 81, and depending on the working environment where the safety component is installed and used.











0.4.1 HAZARD PICTOGRAMS

SYM-BOLS	DESCRIPTION	SYM-BOLS	DESCRIPTION
	General hazard.		Danger of shearing upper limbs.
	Electrical hazard.		Danger of moving parts.
	Danger of crushing upper and lower limbs.		Danger of entanglement and dragging.
	Danger of crushing upper limbs.		

0.4.2 PROHIBITION PICTOGRAMS

SYM-BOLS	DESCRIPTION	SYM-BOLS	DESCRIPTION
	General restriction.		Prohibition to push.
	Forbidden to remove the safety devices.		Do not extinguish fire with water.
	Prohibition of intervention on moving parts.		Prohibition to change the status of the switch.
	Keep hands clear.		Prohibition of placing heavy loads.
	No smoking or open flames.		

0.4.3 MANDATORY PICTOGRAMS

SYM-BOLS	DESCRIPTION	SYM-BOLS	DESCRIPTION
	Generic obligation.		Obligation to wear the protective shield.
	Obligation to read the instruction manual.		Obligation to wear hearing protection.
	Protective gloves must be worn.		Obligation to check the safety devices.
	Safety shoes must be worn.		Obligation to ensure grounding.
	Obligation to wear protective helmet.		Safety goggles must be worn.
	Protective clothing must be worn.		

0.5 GENERAL SAFETY WARNINGS



Please read this manual carefully before commissioning, operating, maintaining or otherwise working on the safety component.

- Personnel involved in the use and maintenance of the safety component must wear clothing that is appropriate for the working environment and the situation in which they find themselves; in particular, the use of very loose clothing, chains, bracelets, rings or anything else that has a tendency to become entangled with moving parts must be avoided.
- Before starting work, personnel must be fully aware of the position and operation of all controls and the characteristics of the machine on which the safety component is mounted.
- It is absolutely forbidden to carry out any maintenance, adjustment or setting operations with moving parts; before carrying out any of these operations, follow the specific instructions in each paragraph.
- Use only original parts made by the Manufacturer.
- During all maintenance, repair or adjustment operations, it is always useful to affix a warning sign on the control panel on board the machine or on the general power supply switches (electric, pneumatic, etc.); this sign may state the following: ATTENTION! DO NOT TOUCH - MAINTENANCE IN PROGRESS. Any maintenance work must only be carried out with the machine switched off and disconnected, by qualified personnel and when the prerequisites for safe working on the safety component are in place. In order to isolate the machine from energy sources, disconnect voltage through the main switches and lock them.
Some of the types of switches used and the padlocking operation are shown in the figure.



- Operators are obliged to immediately report to their direct supervisors any deficiency and/or potential dangerous situation that may occur on the safety component; this must be done after it has been shut down and sectioned.
- Do not, for any reason, modify parts of the safety component (such as attachments, drillings, finishes) to fit additional devices; in the event of a malfunction due to a failure to comply with the above, the manufacturer is not liable for the consequences.
- For operation and maintenance of commercial components mounted on the safety component, please refer to the manuals enclosed or retrievable online.

0.6 LIMITATIONS AND LIABILITY

Any operation NOT explicitly described or NOT explicitly permitted by this manual is strictly forbidden. No liability, civil, criminal or otherwise, can be attributed to its manufacturer in the event of an accident occurring due to failure to comply with safety regulations.

Whoever purchases and/or gives or receives such equipment without acknowledging the validity of the preceding clauses shall immediately renounce the use of such equipment, otherwise the preceding clauses shall be deemed to be explicitly and irrevocably accepted by the mere switching on and use of the equipment.

0.7 RECIPIENTS AND STORAGE

The RECIPIENTS of this manual are:

- Technician Installer: the technical personnel in charge of installing and commissioning the safety component on the machine, who, in addition to being professionally trained in their task, must read the manuals paying particular attention to safety regulations;
- User: personnel assigned to work on the machine, who, in addition to being professionally trained in their task, must read the manuals paying particular attention to the safety regulations and the paragraphs relating to their competence.
- Maintenance Technician: technical personnel in charge of ordinary and extraordinary maintenance of the equipment, must read the manuals paying particular attention to the safety regulations and the paragraphs relating to their competence.

0.8 WARRANTY AND CORRECT USE

This Conventional Warranty offered by the manufacturer will be fully valid during the period indicated below, exclusively in accordance with the provisions:

- For the duration of 12 (twelve) months from receipt of the product, commencing on the date stated on the relevant transport document (DDT), unless otherwise defined in the sales contract with the purchasing party.
- The warranty covers only replaced parts, with the exception of labour.
- Components subject to unavoidable wear and tear due to normal service, such as plastic protection shields and the like, are not covered by the Warranty; damage to the safety component caused by: Transport and/or handling - Operator errors - Incorrect connection to the machine's electrical system - Failure to carry out the maintenance required by this manual - Faults and/or breakage of the machine on which it is installed that cannot be attributed to its malfunction.

1.1 MANUFACTURER'S IDENTIFICATION DATA

COMPANY NAME:

TECNO PIÙ S.r.l.

Registered office:

Via Tempio Malatestiano, 21
47921 Rimini (RN) – Italy

Offices and factory:

Via Pio la Torre, 5
61010 Tavullia (PU) – Italy

Ph.

+39 0721 476381

E-mail

info@tecnopiu.it

Website:

www.tecnopiu.it

1.2 DESCRIPTION OF THE SAFETY PART

The safety component: mod. PAL 01 allows the operator to protect himself from direct contact with the rotating parts of the self-centring spindle and from the projection of some of the swarf and coolant generated during machining. Equipped with two screens made of transparent plastic material, it provides a clear view of the 'segregated' area and the progress of the work currently active.

Equipped with a safety switch to intercept the closed position, which when electrically connected allows the self-centring spindle motor to start only in the maximum closed position of the guard.

Ensure that the dimensions of the safety guard are suitable for the type of machine.



Before proceeding with the installation of the safety device, check and where necessary prepare the machine with appropriate support brackets, holes and anything else for the correct anchoring of the safety device to the machine itself. Carefully follow the measurements and centre distances of the fixing brackets supplied with the safety device.



Drawing 1

1	Front screen
2	Sliding support trolley for mobile guard
3	Carrying rail fitted with slide systems on ground profile
4	Counterweight group
5	Screen clamp
6	Bump stop
7	Safety microswitch no. 2 NC contacts

CODE PAL 01	A	B	C	Kg
PAL 01/780	700	800	2000	30.0
PAL 01/S	/	/	/	/



The safety component has been designed and built to work in a professional environment and by professional operators who are informed and trained for this purpose.



The safety component has been designed and constructed for only those types of machines whose characteristics are listed in this manual



The protection screen must be periodically checked and replaced if it is damaged due to normal wear and tear or as a result of accidental impacts.



Worn parts of the safety component must be properly checked and, if necessary, replaced with original spare parts.



For proper use of the safety component, good maintenance and cleaning of the component must be scrupulously observed.

2.1 REASONABLY FORESEEABLE IMPROPER USE

Reasonably foreseeable misuse includes all uses not explicitly mentioned in this manual, in particular:

- Use of the safety component in a non-professional environment or by non-professional personnel;
- Use of the safety component by unauthorised and untrained personnel;
- Use of the safety part in an environment other than that specified in the contract;
- Use of the safety component in conditions of use outside the limits given in this manual;
- Use of products other than those specified in the contract and possibly in this manual.
- Use of the safety component damaged or with missing parts.



The above reasonably foreseeable misuse and all uses not explicitly stated in this manual are prohibited.



It is forbidden to use the safety component in environments with explosive atmospheres.



It is forbidden to make changes to the safety component.



Modifications to the safety component for uses other than those intended shall invalidate the conformity of the safety component and the manufacturer's liability.



It is forbidden to use the safety component until it has been correctly installed. It is strictly forbidden to tamper with, bypass or disable the safety devices on the component.



It is forbidden to remove and tamper with safety devices; Tampering with them exposes the operator to contact with dangerous machine parts.



It is forbidden to remove the screen.



It is forbidden to use the safety component without the appropriate personal protective equipment.



The operator must use the personal protective equipment intended for use with the machine.

2.1.1 MICROSWITCHES

Microswitches are the devices that monitor the opening and closing status of mobile guards. They are interlocked to the control circuit that manages their safety functions.

The mobile guard installed is equipped with a safety microswitch that stops the machine if it is opened during the operating cycle, not allowing it to restart as long as the guard remains open and until the circuit is reset by the relevant procedure.

There are different types of microswitches including, for example, key switches, hinge switches, magnetic switches, etc.



DO NOT use the safety component for normal machine stop.

2.2 COPY OF THE DECLARATION OF CONFORMITY

Below is a copy of the Declaration of Conformity.

The original copy accompanies the safety component and is filed with the manufacturer.



SEDE LEGALE:
Via Tempio Malatestiano, 21
47921-RIMINI (RN)-ITALY

SEDE OPERATIVA:
Via Pio La Torre, 5
61010-TAVULLIA (PU)-ITALY
Tel. +39 0721 476381-476131
Fax. +39 0721 476608
www.tecnopiu.it-info@tecnopiu.it

TECNOPIÙ S.R.L. - COD. FISCALE/P.NA/REG. IMP. RIMINI IT03657258487 - R.E.A. N. 382624 - CAPITALE SOCIALE 58.888,88 LV.

DICHIARAZIONE DI CONFORMITÀ
DECLARATION OF CONFORMITY
DÉCLARATION DE CONFORMITÉ
DECLARACIÓN DE CONFORMIDAD
KONFORMITÄTSEKLRUNG
ДЕКЛАРАЦИЯ СООТВЕТСТВИЯ

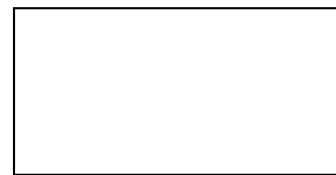

<p>è conforme alle direttive: - Direttiva 2006/42/CE</p> <p>Norme armonizzate: UNI EN ISO 12100:2010 CEI EN 60204-1:2018 UNI EN ISO 14120:2015</p> <p>Persona autorizzata alla compilazione del fascicolo tecnico: Tecno Più srl Via Tempio Malatestiano, 21 47921 Rimini (RN) - ITALY</p>	<p>conforms to directives: - Directive 2006/42/EC</p> <p>Harmonized standards: UNI EN ISO 12100:2010 CEI EN 60204-1:2018 UNI EN ISO 14120:2015</p> <p>Authorized person to fill in the technical file: Tecno Più srl Via Tempio Malatestiano, 21 47921 Rimini (RN) - ITALY</p>	<p>conforme aux directives: - Directive 2006/42/CE</p> <p>Normes harmonisées: UNI EN ISO 12100:2010 CEI EN 60204-1:2018 UNI EN ISO 14120:2015</p> <p>Personne autorisée à compléter le dossier technique: Tecno Più srl Via Tempio Malatestiano, 21 47921 Rimini (RN) - ITALY</p>
--	--	---



<p>conforme a las directivas: - Directiva 2006/42/CE</p> <p>Normas armonizadas: UNI EN ISO 12100:2010 CEI EN 60204-1:2018 UNI EN ISO 14120:2015</p> <p>Persona autorizada a la elaboración módulo técnico: Tecno Più srl Via Tempio Malatestiano, 21 47921 Rimini (RN) - ITALY</p>	<p>Entsprechend den Richtlinien: - Richtlinie 2006/42/CE</p> <p>Harmonisierte Normen: UNI EN ISO 12100:2010 CEI EN 60204-1:2018 UNI EN ISO 14120:2015</p> <p>Berechtigter zum Ausfüllen der technischen Unterlagen: Tecno Più srl Via Tempio Malatestiano, 21 47921 Rimini (RN) - ITALY</p>	<p>Соответствует директивам: - Директива 2006/42/ЕС</p> <p>Гармонизированные стандарты: UNI EN ISO 12100: 2010 CEI EN 60204-1: 2018 UNI EN ISO 14120: 2015 Уполномоченное лицо для заполнения технической документации: Tecno Più srl Via Tempio Malatestiano, 21 47921 Rimini (RN) – ИТАЛИЯ</p>
--	---	--

Rimini,

Legale rappresentante
Legal representative
Représentant légal
Representante legal
Rechtsvertreter
Законный представитель



3.1 SUPPLY STATUS AND PREPARATION

The costs, as well as the preparation of the safety component on the machine, are borne by the Customer and include:

- Prepared for anchoring on the machine;
- The Power Supply of the machine, in accordance with the Standards in force in the Country of use.

Installation requires a manoeuvring area around the machine appropriate to the requirements of the operations to be performed.

The general packaging is in any case in the form of one or more sturdy cardboard boxes, in which the various individual packages are suitably placed inside, which are in turn well protected from each other by suitable material (cardboard and expanded polystyrene plugs).

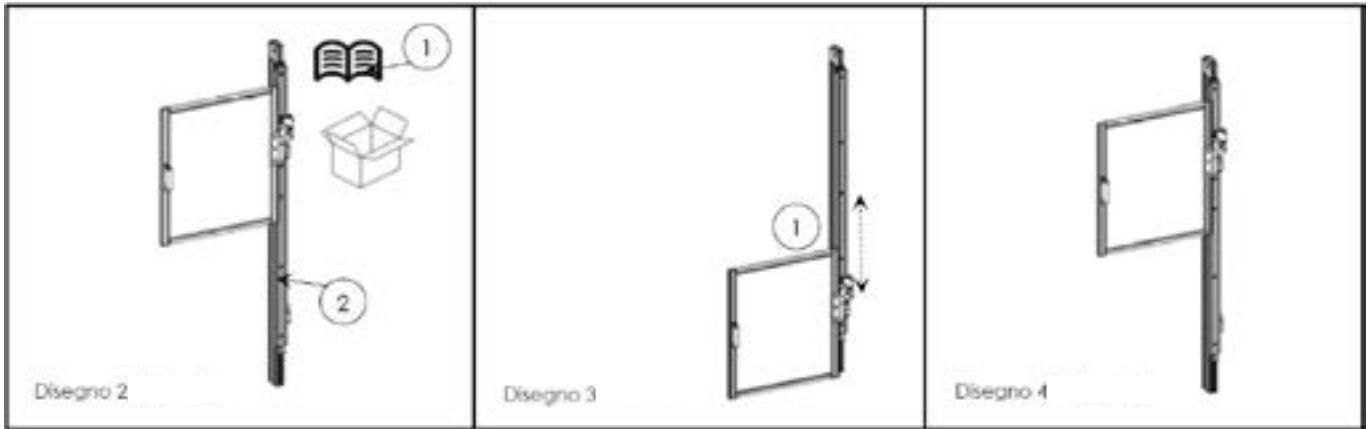

4.1 PREPARATION

The package contains - ref. drawing (2):

1. the technical documentation;
2. the complete folded guard - drawing (2) detail (1);
3. the anchorage kit to the operating machine - drawing (2) detail (2):
 - No. 4 screws M8x30;
 - No. 4 washers M8x16.

4.2 ASSEMBLY

The assembled guard should look like in the reference drawing (4).

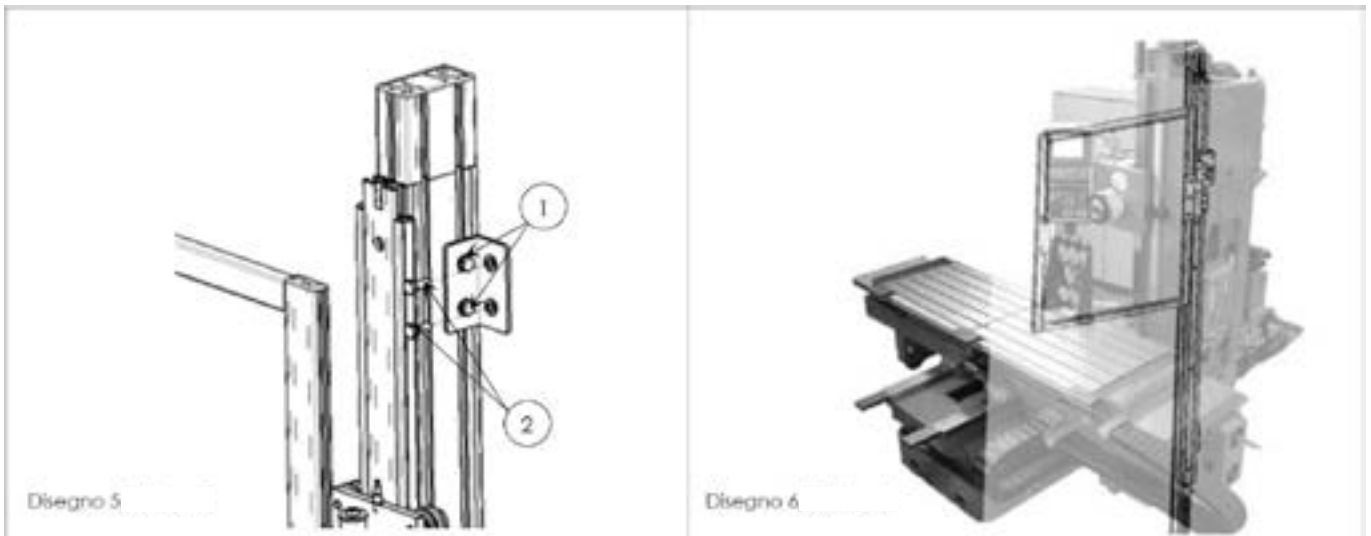

4.3 INSTALLATION

The assembled guard must be properly secured to the operating machine by means of suitable supports and fastening systems.

The protection is supplied as standard with 4 screws M8x30 and 4 washers M8x16 - drawing (5) detail (1,2):

1. Proceed with checking the adjustment and centring of the guard and the measurements as in drawing (5);
2. the guard must be fixed to the machine as in - drawing (6);
3. check the opening and closing of the guard as shown in - drawing (8) details (A,B).

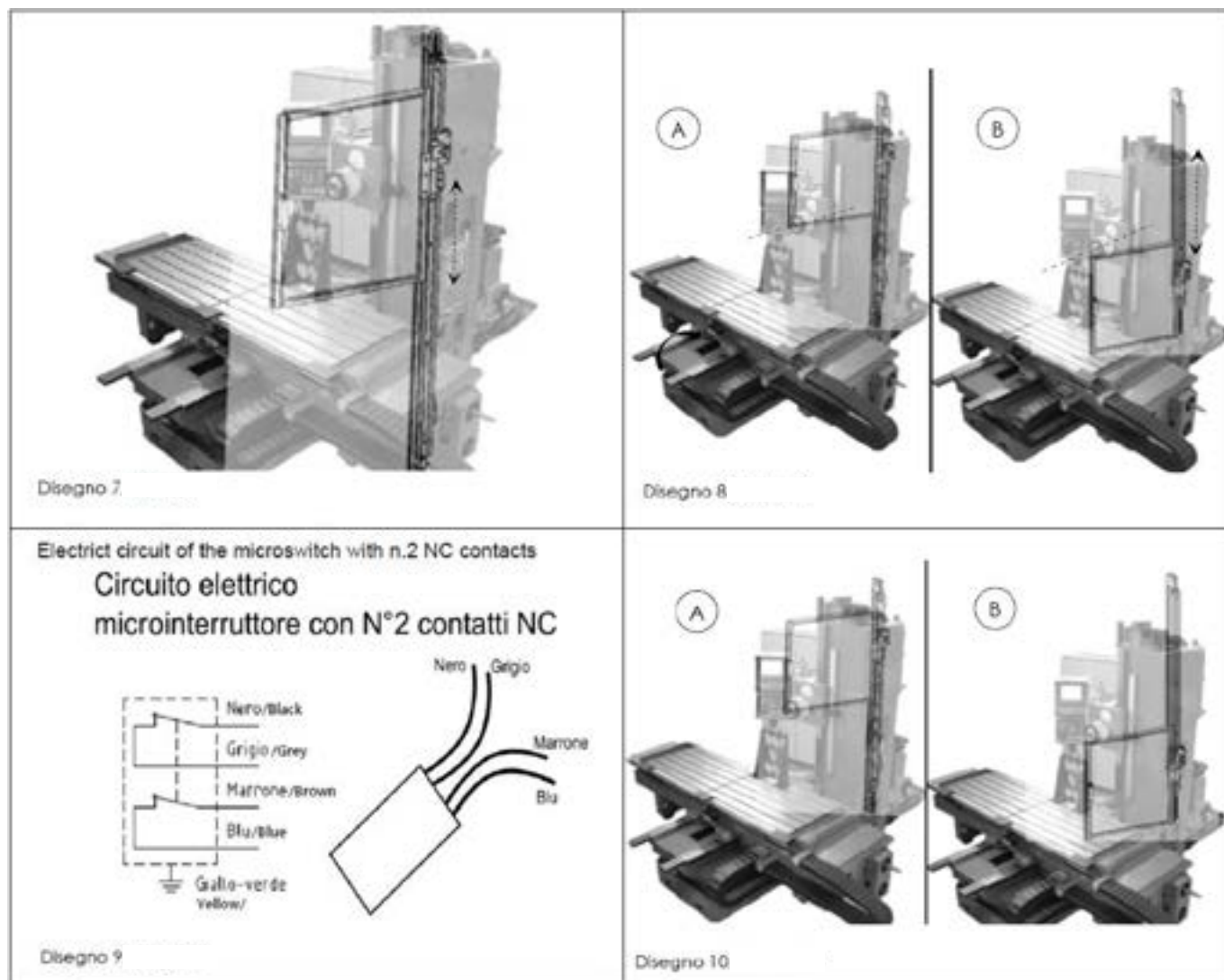

4.4 ELECTRICAL CONNECTION

The installed guard must be properly connected to the operating machine to perform the safety function as required by the standards. The electrical connection must be made according to the diagram in - drawing (9). For the specific characteristics of the microswitch, please refer to the attached component data sheet. In any case, check the enclosed microswitch card, incorrect connections could jeopardise the safe operation of the operating machine.

4.5 START-UP

Having completed the mechanical assembly as in drawing (5) of the guard and its electrical connection to the machine's safety circuit, it is necessary to check the correct functioning of the assembly, proceeding as follows:

1. check the protection settings for the screen assembly - drawing (10) details (A,B);
2. it must only be possible to start the spindle motor with the guard in the closed position, i.e. in the position shown in - drawing(10) detail (A);
3. on the contrary, when the guard - drawing(10) detail (B) - is opened, the spindle motor must stop immediately and its restart must necessarily require in sequence, the repositioning of the guard and the starting of the motor by a voluntary manoeuvre, from the control provided for this purpose.

4.6 RESPONSIBILITY OF THE INSTALLER

The instructions contained in this manual are to be considered as indicative for the installation and commissioning of the safety guard, the consultation and requirements of the regulations are in no way exempt. Installation must be carried out by appropriately trained technical personnel.

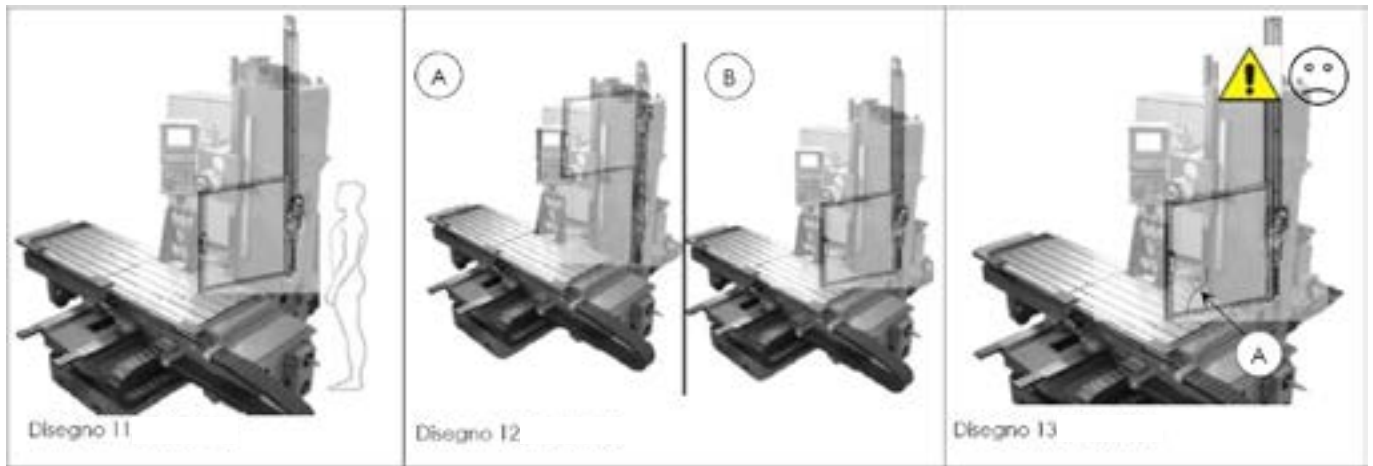

5.1 WORKSTATION

The safety guard PAL 01 protects the operator from the front, observe the working position as shown in drawing (11).

5.2 BEFORE STARTING ANY WORK

Before starting any work, it is necessary:

1. Check the intact state of the protective screen, if you notice any cracks or splits as shown in drawing (13) detail (A) - contact the maintenance service immediately for replacement of the damaged part.
2. Check the correct operation of the safety microswitch by starting the operating machine with the safety guard closed - drawing (12) detail (A) - and simulating a stop by opening the safety guard - drawing (12) detail (B) -, if the safety guard fails to trip, contact the maintenance service immediately and disconnect power to the operating machine.
3. If the operations in the previous points have been successful, proceed with the registration of protection and the start of work.

6.1 MAINTENANCE FOR INSTALLATION TECHNICIAN

Any cleaning of the safety component must be carried out with the machine switched off and performed by personnel suitably trained in routine maintenance operations.

Cleaning of the various components can be carried out with common universal degreasers, absolutely no corrosive agents or solvents should be used.

The transparent screen is easy to clean, proceed as follows:

- Dusty surfaces must first be blown with compressed air;
- Do not wipe dry with abrasive rags or sponges, as this will alter the transparency of the surface;
- Use a common neutral soap (also for domestic use) and a dishcloth or special paper, after removing any abrasive particles.

It is recommended to clean the safety component and its protective screen as often as necessary in order to always have a clear and safe view of the area concerned.

The protective screen tends to lose its initial transparency with time and wear, so its periodic replacement is recommended.



IT IS FORBIDDEN TO USE ALCOHOL, SOLVENTS OR AGGRESSIVE DEGREASERS.

7.1 GENERAL WARNINGS

- The disposal and scrapping of the safety component must be carried out by qualified personnel who are familiar with the safety regulations for the type of work to be performed.
- As the safety component is disconnected from the various sources of energy, the operator must wear the personal protective equipment deemed most appropriate according to the type of residual or inherent danger when disassembling the parts.
- During disassembly, ensure that the parts of the safety component to be removed are of a weight that can be lifted individually by the operator and that there is no danger of falling during disconnection.
- In case of past use of the safety component with toxic materials for dismantling, it is recommended to use protection for the respiratory tract and exposed parts.
- The treatment to be reserved in this case must be the specific knowledge of the user, who must apply the strictest safety and disposal regulations.



Please refer to section 0.5 GENERAL SAFETY WARNINGS.

7.2 DECOMMISSIONING

If it is necessary to take the safety component out of service, it is also necessary to carry out all necessary operations to take the machine itself out of service, because, **THE MACHINE IS NOT IN SAFE CONDITIONS.**

7.3 WASTE DISPOSAL AND PACKAGING

If you decide to no longer use the safety component which is the subject of this manual, because it is obsolete or irretrievably defective or worn out, take it out of service using the following procedures:

1. Make sure the machine is stopped and disconnected from the main power supply.
2. Check for the absence of residual, potential and kinetic energies.
3. If it is useful to reduce its size and/or facilitate transport, disassemble its various parts very carefully.

Dispose of it in accordance with the regulations in force in your country of use, contacting companies specialised in scrapping, recycling and disposal of equipment.

The correct disposal of this product contributes to preventing potential negative consequences that might derive from an inadequate disposal of the product.

The equipment consists of non-biodegradable parts and substances that can pollute the environment if not properly disposed of, and parts of these materials can be recycled without polluting the environment.

It is your and our duty to contribute to human health and environmental protection.

Dispose of packaging materials by separating them according to their nature and according to the relevant legislation in the country of use.

Materials bearing this symbol are recyclable and must be stored in the appropriate spaces and/or containers.

Enquire with the competent local authority.

7.4 SPARE PARTS AND SERVICE

Contact your dealer or the company's Technical Customer Service directly, providing the necessary data that can be found on the nameplate on the guard:

- Type of guard;
- Serial number;
- Date of purchase;
- Moreover, supply all the information that concerns the experienced inconvenience.



Tecno Più Srl
Via Tempio Malatestiano, 21
47921 Rimini (RN)
Tel. +39 0721 476381
website: www.tecnopiu.it